

Main model: ONYX-MD101

**Series Model: xxxONYX-MD101xxxxxxxx(x=0~9, A~Z,
a~z or blank or slash; for marketing purpose only and no
impact safety related constructions and critical components)**

10.1" LCD with LED Backlight
Intel® Cherry Trail Z8350 Processor
Mobile Medical Assistant Tablet

Copyright Notice

This document is copyrighted, 2017. All rights are reserved. The original manufacturer reserves the right to make improvements to the products described in this manual at any time without notice.

No part of this manual may be reproduced, copied, translated, or transmitted in any form or by any means without the prior written permission of the original manufacturer. Information provided in this manual is intended to be accurate and reliable. However, the original manufacturer assumes no responsibility for its use, nor for any infringements upon the rights of third parties, which may result from its use.

The material in this document is for product information only and is subject to change without notice. While reasonable efforts have been made in the preparation of this document to assure its accuracy, ONYX Healthcare Inc., assumes no liabilities resulting from errors or omissions in this document, or from the use of the information contained herein

ONYX Healthcare Inc. reserves the right to make changes in the product design without notice to its users

Acknowledgments

- Intel® Cherry Trail is registered trademarks of Intel® Corporation.
- Microsoft® Windows is a registered trademark of Microsoft® Corporation.

All other product names or trademarks are properties of their respective owners.

Packing List

Before you begin installing your Mobile Medical Assistant Tablet PC, please make sure that the following items have been shipped:

- ONYX-MD101 Mobile Medical Assistant Tablet
- Medical Power Adapter 15V/2.4A
- Utility DVD-ROM, which contains Drivers and Utilities
- VESA Cradle (Optional)

If any of these items are missing or damaged, you should contact your distributor or sales representative immediately.

Headquarters

Onyx Healthcare Inc.

2F, No.135, Lane 235, Pao-Chiao Rd.,

Hsin-Tien City, Taipei 231, Taiwan, R.O.C.

TEL: +886-2-8919-2188

FAX: +886-2-8919-1699

E-mail: sales@onyx-healthcare.com

<http://www.onyx-healthcare.com>

Worldwide Offices:

Onyx Healthcare, USA Inc.

324W. Blueridge Ave., Orange,, CA 92865, USA

Tel : +1-714-792-0774

Fax: +1-714-792-0481

Email: usasales@onyx-healthcare.com

Onyx Healthcare EUROPE B.V.

Primulalaan 42, 5582 GL Waalre, Netherlands

Tel : +31(0)499-745600

Email: eusales@onyx-healthcare.com

**Mobile Medical Assistant
Tablet**

ONYX-MD101

Onyx Healthcare (Shanghai) INC.

20F, unit D, GEM Building, No. 487 Tianlin Road,

Shanghai, China

Tel: +86-021-64956588

Fax: +86-021-64956889

Email: cnsales@onyx-healthcare.com

Safety & Warranty

1. Read these safety instructions carefully.
2. Keep this user's manual for later reference.
3. Disconnect this equipment from any AC outlet before cleaning. Do not use liquid or spray detergents for cleaning. Use a damp cloth.
4. For pluggable equipment, the power outlet must be installed near the equipment and must be easily accessible.
5. Keep this equipment away from humidity.
6. Put this equipment on a reliable surface during installation. Dropping it or letting it fall could cause damage.
7. The openings on the enclosure are for air convection. Protect the equipment from overheating. **DO NOT COVER THE OPENINGS.**
8. **Make sure the voltage of the power source is correct before connecting the equipment to the power outlet.**
9. **Any person who connects external equipment or signal input, signal output, or other connectors has formed a system and is therefore responsible for the system to comply with the standard IEC 60601-1, safety requirements for medical electrical systems.**
10. Position the power cord so that people cannot step on it. Do not place anything over the power cord.
11. All cautions and warnings on the equipment should be noted.
12. If the equipment is not used for a long time, disconnect it from the power source to avoid damage by transient over-voltage.

13. Never pour any liquid into an opening. This could cause fire or electrical shock.

14. Never open the equipment. For safety reasons, only qualified service personnel should open the equipment.

15. Warning: Do not modify this equipment without authorization of the manufacturer. (Avertissement: Ne pas modifier cet équipement sans l'autorisation du fabricant)

16. Warning : It is necessary for checking or replacing the battery pack every year. (Avertissement: Il est nécessaire de vérifier ou de remplacer la batterie chaque année)

16. If any of the following situations arises, get the equipment checked by service personnel:

- a. The power cord or plug is damaged.
- b. Liquid has penetrated into the equipment.
- c. The equipment has been exposed to moisture.
- d. The equipment does not work well, or you cannot get it to work according to the users manual.
- e. The equipment has been dropped and damaged.
- f. The equipment has obvious signs of breakage.

17. DO NOT LEAVE THIS EQUIPMENT IN AN UNCONTROLLED ENVIRONMENT WHERE THE STORAGE TEMPERATURE IS BELOW -20° C (-4°F) OR ABOVE 60° C (140° F). IT MAY DAMAGE THE EQUIPMENT.

18. External equipment intended for connection to signal input/output or other connectors, shall comply with relevant UL / IEC standard (e.g. UL 1950 for IT equipment and ANSI/AAMI ES 60601-1: 2005 AND CAN/CSA-C22.2 No. 60601-1:08 / IEC 60601 series for systems – shall comply with the standard IEC 60601-1-1, Safety requirements for medical electrical systems. Equipment not complying with UL 60601-1 shall be kept outside the patient environment, as defined in the standard.

19. Unplug the power cord from the power adapter jack to disconnect the device.

Caution:

It may cause the danger of explosion if battery is incorrectly replaced. Replace only with same or equivalent type recommended by the manufacturer.

Classification

1. Degree of protection against electric shock: not classified
2. Mode of operation: Continuous
3. Type of protection against electric shock: Class II equipment
4. No Applied Part, No AP/APG

FCC

Warning!



This device complies with Part 18 FCC Rules. Operation is subject to the following two conditions: (1) this device may not cause harmful interference, and (2) this device must accept any interference received including interference that may cause undesired operation.







UL Module Description



*ONYX-MD101 modules are developed to
suitable for the Classification Mark
requirement*

Safety Symbol Description

The following safety symbols are the further explanations for your reference.

	<p><i>Medical equipment with respect to electric shock, fire and mechanical hazards only in accordance with ANSI/AAMI ES60601-1 - Amendment 1 - Revision Date 2012/08/21 and CAN/CSA-C22.2 No. 60601-1:14</i></p>
	<p><i>Attention, consult ACCOMPANYING DOCUMENTS.</i></p>
	<p><i>Stand-by</i></p>
	<p><i>Class II equipment</i></p>
	<p><i>Alternating current</i></p>
	<p><i>Direct current</i></p>

Contents

Chapter 1 General Information

1.1 Introduction.....	1-2
1.2 Feature	1-3
1.3 Specification	1-4
1.4 Dimension	1-8

Chapter 2 Hardware Installation

2.1 Safety Precautions	2-2
2.2 Quick Tour of the ONYX-MD101	2-3
2.3 Turn On and Boot up into Windows.....	2-7
2.4 Turn off.....	2-7

Chapter 3 Driver Installation

Appendix A Miscellanea

A.1 General Cleaning Tips.....	C-2
A.2 Cleaning Tools	C-3
A.3 Scrap Computer Recycling	C-5

Chapter

1

**General
Information**

1.1 Introduction

Vital Sign is a building block of all the tasks nurses do every day, and also a fundamental element for doctors to determine what kind of treatment and medication should to be given. How to optimize nurses' time and improve the data correctness by automating the vital sign frontline reporting is the winning key to deliver an excellent nursing care service. ONYX-MD101 is designed for this purpose. With the integration of ECG devices, e.g. GE V100, and intuitive software UI, ONYX-MD101 is working as a Gateway to transfer and document all the data liked NIBP, SpO2, pulse rate and temperature into HL7 format, which is a common protocol nowadays to be addressed by many different world-known EMR software.

By consistency, doctors/clinicians can utilize the data among the ward, operation room, nurse station, pharmacy, and even outside facilities, like hemodialysis center, nursing care house and home.

Features

1. 10.1" Automated Vital Sign Tablet
2. Fast and complete data exchange among all care areas
3. Improve the accuracy of vital sign records.
4. Seamless integration of various devices, liked BP Monitor, Respirator, Anesthesia Machine, Injection Pump...etc.
5. Ergonomic roll stand with quiet and stable wheels (Easy to push) for high mobility
6. Considerable Cable management for Pulse Oximetry, Blood pressure Wristband and Barcode Gun...etc.

1.2 Feature

- Intel® Cherry Trail processor
- Slimmer & light weight design for clinical mobility
- Long life battery, supports intensive care service
- Standard USB Type-A for easy connection with medical device
- 3 feet drop resistant
- ORION client compatible
- Support VESA 75 via VESA Cradle
- EN60601-1 & UL60601-1 Certified
- Ergonomic design for portable and trolley use

1.3 Specification

Main System Specifications

CPU	Intel® Cherry Trail Z8350 1.44GHz (2M Cache, up to 1.92 GHz)
System Memory	DDR3L on board, support up to 4GB (2GB/4GB)
Storage	eMMC on board, support up to 128GB (64GB/128GB)
I/O	<p>USB 3.0 (Type-A) x1</p> <p>3.5mm Combo Audio Jack x1</p> <p>Micro HDMI Out x1(Removable)</p> <p>Kensington slot x1</p> <p>[Note] The connected of SIGNAL INPUT/OUTPUT PART need to compliance with IEC standard.</p>
Wireless Communication	AMPAK.WL334: 802.11 a/b/g/n + BT 4.0
GPS	u-blox.NEO-M8Q-0
Gyroscope Sensor	Bosch.BMG160
Accelerometer Sensor	Bosch.BMC150
Audio Codec	<p>Main Audio Codec: REALTEK.ALC5672-VB-CGT</p> <p>2nd Audio Codec is built for Audio Jack function.</p>
Speaker	3W speaker x2
Security	fTPM (A Firmware-based TPM)
Power input	15V DC / 2.4A
Battery	<p>Liyhium-Ion Battery</p> <p>Manufacturer: GLW</p>

	Model Name: OPM-P06T, Rating: 11.4Vdc 4090mAh/46.62Wh
System Cooling	Fan less
Output power	IEEE_ 802.11b: 17.44 dB m IEEE_ 802.11g: 18.09 dB m IEEE 802.11n 2.4GHz 20MHz: 18.11 dBm UNII_Band_I: 18.48_dBm UNII_Band_II: 18.03_dBm UNII_Band_III: 16.32 dBm

Front Panel Design

Control Button	Power Button : x1 Volume Keys: x2 Home Key: x1
DMIC	Integrated into the Button Board
Camera	Rear 8.0/ Front 2.0M pixels camera (Removable)
RFID	NA
Smart Card Reader	NA
Alarm Light	Integrate to the Button Board (EC Control) 1. Flick Orange: Every 0.5s 2. Orange: 3. Flick Blue: Every 0.5s 4. Blue: [Note]

	<ol style="list-style-type: none"> Function disable when power off Function reset to LEDs-off after restart to OS
LED Battery Indicator	<p>[w/ adaptor] Charging => Blue LED.</p> <p>[w/ adaptor] Full => Green LED (Ready to use).</p> <p>[no adaptor] <10%, Power Off, Blue LED Flick 3 Times</p> <p>[no adaptor] Power on & S3, <10%, Blue LED Flick 3 Times</p> <p>Thermal Sensor detect (>42 degreeC) : Shut down</p>
Light Sensor	YES

Display Specification

LCD size	10.1" Color TFT-LCD
Brand	ONation
LCD Model Number	OT101ZBWDLN-09
Resolution	1920 x 1200
Luminance (cd/m2)	300
Contrast Ratio	1000:1
Viewing Angel	Horizontal: Right 85 (Typ) / Left 85 (Typ) Vertical: Up 85 (Typ) / Down 85 (Typ)
Interface	MIPI
Backlight Life Time (Hrs.)	30,000
Weight	127g

Note:

All ONYX LCD products are manufactured with High precision technology. However, there are a small number of defective pixels in all LCD panels that are not able to change color. This is a normal occurrence for all LCD displays from all

manufacturers and should not be noticeable or objectionable under normal operation. All LCD panels are qualified for industry standard conditions in the following: total 7 dead pixels on a screen or if there are 3 within 1 inch square area of each other on the display.

Touch Screen Specification

Touch Type	PCT
Brand	EDT
Touch Model Number	EP1010MLM2
TS Controller	SIS9255B
Interface	USB

Power Adapter Specification

Model	Medical Adapter , Adapter Technology Co. Ltd. ATM036T-A150
AC input	100-240V AC@50-60 Hz
DC output	15V / 2.4A, 36W max

Mechanical Specifications

Architecture	Magnesium Aluminum Alloy Rear Cover + Plastic casing
Color	Font Cover: Black, Rear Cover: Brown
Mounting	VESA 75mm (Via VESA Cradle)
Dimension (W x H x D)	260 x 186 x 23 (mm)

Net Weight	Approx. 1Kg
-------------------	-------------

Accessory

Cradle	VESA 75 with Locking
---------------	----------------------

Environmental Specifications

Operating Temperature	-10°C ~ 40°C (14°F ~ 86°F)
Operating Humidity	30% to 75% RH, non-condensing
Operating Pressure	700 to 1060 hPa
Storage Temperature	-20°C ~ 60°C (-4°F ~ 140°F)
Storage Humidity	10%~95%@35°C, non-condensing
Storage Pressure	700 to 1060 hPa
Vibration	0.5G / 5 ~ 500Hz (Random) / operation
Shock	20G peak acceleration (11 msec. duration) / operation
Drop(with packaging)	80 cm (1 Corner, 3 Edge, 6 Surface)

1.4 Dimension

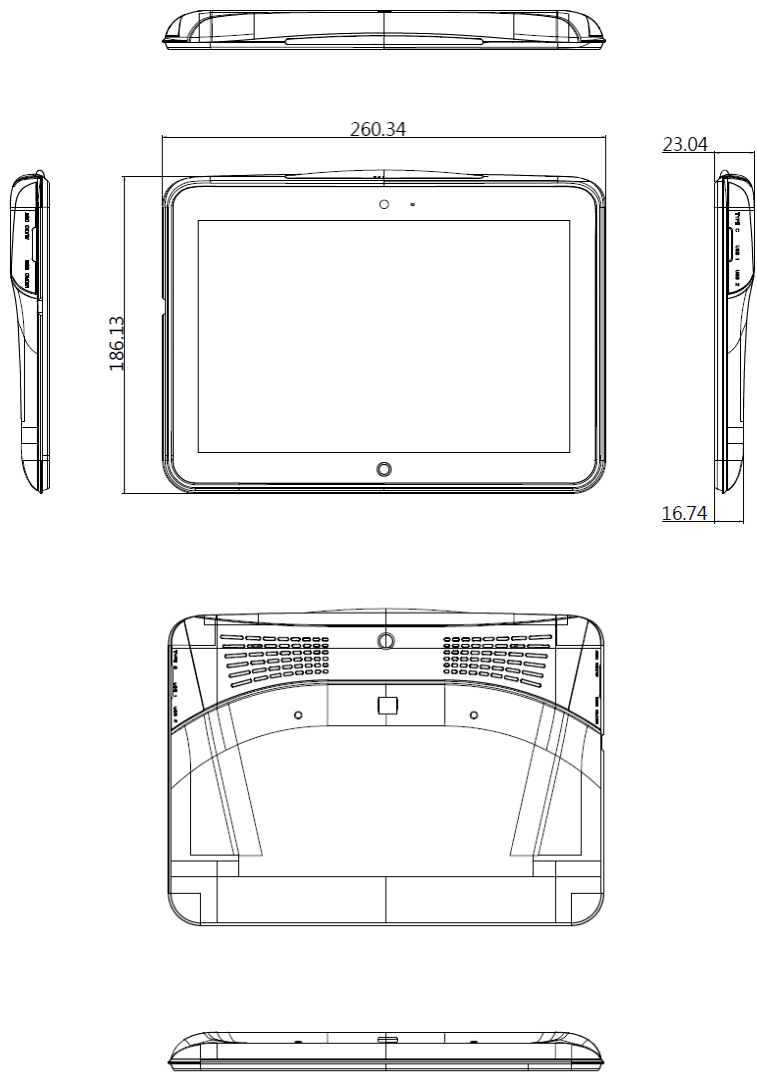

Chapter

2

Hardware Installation

2.1 Safety Precautions

Warning!



Always completely disconnect the power cord from your board whenever you are working on it. Do not make connections while the power is on, because a sudden rush of power can damage sensitive electronic components.

Caution!



Always ground yourself to remove any static charge before touching the board. Modern electronic devices are very sensitive to static electric charges. Use a grounding wrist strap at all times. Place all electronic components on a static-dissipative surface or in a static-shielded bag when they are not in the chassis

2.2 Quick Tour of the ONYX-MD101

Before you start to set up ONYX-MD101, take a moment to become familiar with the locations and purposes of the controls, drives, connections and ports, which are illustrated in the figures below.

When you place ONYX-MD101 upright on the desktop, its front panel appears as shown in Picture 2-1. The ONYX-MD101 includes various I/O ports in left and right side, including a DC-IN Jack, an Audio Jack, one USB ports and one Micro HDMI output.



Picture 2.1: Front View of the ONYX-MD101

When you turn the ONYX-MD101 around and look at its rear cover, it contains an 8MP camera and high quality of stereo speakers.



Mounting

ONYX-MD101 comes with a VESA cradle, which is equipped a standard 75x75 mm VESA holes from rear side for bracket mount.



2.3 Turn On and Boot up into Windows OS

This section is for Windows operating system only. If you are installing a different operating system, please contact your vendor for installation details.

Your ONYX-MD101 will begin loading Windows OS once you push the power button to turn power on. After less than one minute, Windows desktop screen will appear.

You can select the programs from the start menu in the left-down corner of the desktop screen.

2.4 Turn off

Turning off ONYX-MD101 properly is important for system reliability. There are two ways to turn off the system.

1. On the start menu, click “shut down” and select “OK”
2. Push the power button and then the system will shut down automatically

Chapter

3

**Driver
Installation**

There are several installation ways depending on the driver package under different Operating Systems.

Please follow the sequence below to install the drivers:

For Windows 7/8.1/10

Step 1 – Chipset Driver

Step 2 – Graphics Driver

Step 3 – Realtek LAN Driver

Step 4 – Realtek Audio Driver

Step 5 – TPM 2.0 Driver(for Windows 7)

Step 6 – ME Driver

Step 7 – Resistive Touch Screen Driver(only for ET series)

Appendix

A

Miscellanea

A.1 General Cleaning Tips

You may need the following precautions before you begin to clean the computer. When you clean any single part or component for the computer, please read and understand the details below fully.

1. Never spray or squirt the liquids directly onto any computer component. If you need to clean the device, please rub it with a piece of dry cloth.
2. Be cautious of the tiny removable components when you use a vacuum cleaner to absorb the dirt on the floor.
3. Turn the system off before you start to clean up the component or computer.
4. Never drop the components inside the computer or get circuit board damp or wet.
5. Be cautious of all kinds of cleaning solvents or chemicals when you use it for the sake of cleaning. Some individuals may be allergic to the ingredients.
6. Try not to put any food, drink or cigarette around the computer.
7. ONYX Healthcare Inc. has tested and verified these cleaning disinfectants, CIDEX, Viraguard, Control III Disinfectant Germicide, Caviwipes, Dispatch Disinfectant Cleaner CLH69101, Puregreen 24 Disinfectant, can be used with the ONYX-MD101. Use of any other disinfectants will void the warranty.

A.2 Cleaning Tools

Although many companies have created products to help improve the process of cleaning your computer and peripherals users can also use household items to clean their computers and peripherals. Below is a listing of items you may need or want to use while cleaning your computer or computer peripherals.

Keep in mind that some components in your computer may only be able to be cleaned using a product designed for cleaning that component, if this is the case it will be mentioned in the cleaning tips.

- **Cloth** - A piece of cloth is the best tool to use when rubbing up a component. Although paper towels or tissues can be used on most hardware as well, we still recommend you to rub it with a piece of cloth.
- **Water or rubbing alcohol** – You may moisten a piece of cloth a bit with some water or rubbing alcohol and rub it on the computer. Unknown solvents may be harmful to the plastics parts.
- **Vacuum cleaner** - Absorb the dust, dirt, hair, cigarette particles, and other particles out of a computer can be one of the best methods of cleaning a computer. Over time these items can restrict the airflow in a computer and cause circuitry to corrode.
- **Cotton swabs** - Cotton swabs moistened with rubbing alcohol or water are excellent tools for wiping hard to reach areas in

your keyboard, mouse, and other locations.

- **Foam swabs** - Whenever possible it is better to use lint free swabs such as foam swabs.

Note:

We strongly recommended that you should shut down the system before you start to clean any single components.

Please follow the steps below.

1. Close all application programs.
2. Close operating software.
3. Turn off power switch
4. Remove all device
5. Pull out power cable

A.3 Scrap Computer Recycling

If the computer equipments need the maintenance or are beyond repair, we strongly recommended that you should inform us as soon as possible for the suitable solution. For the computers that are no longer useful or work well, please contact with worldwide distributors for recycling.

The worldwide distributors show on the following website:

<http://www.onyx-healthcare.com.tw/Contact.php>

Note:

Follow the national requirement to dispose unit

Appendix

B

Compliance Information

B.1 FCC Statement

Any changes or modifications not expressly approved by the party responsible for compliance could void your authority to operate the equipment.

This device complies with Part 15 of the FCC Rules. Operation is subject to the following two conditions: (1) this device may not cause harmful interference and (2) this device must accept any interference received, including interference that may cause undesired operation.

B1.1 For P15B Equipment

This equipment has been tested and found to comply with the limits for a Class B digital device, pursuant to part 15 of the FCC rules. These limits are designed to provide reasonable protection against harmful interference in a residential installation. This equipment generates, uses and can radiate radio frequency energy and, if not installed and used in accordance with the instructions, may cause harmful interference to radio communications.

However, there is no guarantee that interference will not occur in a particular installation. If this equipment does cause harmful interference to radio or television reception, which can be determined by turning the equipment off and on, the user is encouraged to try to correct the interference by one or more of the following measures:

- Reorient or relocate the receiving antenna.
- Increase the separation between the equipment and receiver.
- Connect the equipment into an outlet on a circuit different from that to which the receiver is connected.
- Consult the dealer or an experienced radio/TV technician for help.

B1.2 For Portable Devices

FCC RF Radiation Exposure Statement:

1. This Transmitter must not be co-located or operating in conjunction with any other antenna or transmitter.
2. This equipment complies with FCC RF radiation exposure limits set forth for an uncontrolled environment. This device was tested for typical hand held operations with the device contacted directly to the human body to the sides of the device. To maintain compliance with FCC RF exposure compliance requirements, avoid direct contact to the transmitting antenna during transmitting.

B.2 Radio Wave Exposure and SAR Information

The SAR (Specific Absorbtion Rate) limit as dictated by the FCC (in the USA) is 1.6W/kg averaged over 1 gram of tissue. In Europe/EU (CE regulations) it is 2.0 W/kg averaged over 10 grams of tissue. The Devices, ONYX-MD101 (FCC ID: RZ5-MD101) have been tested against these SAR limits to maintain compliance with FCC/CE RF exposure requirements.

This equipment complies with FCC/EU RF radiation exposure limits set forth for an uncontrolled environment.

B.3 CE Statement

This equipment complies with the requirements relating to electromagnetic compatibility, the essential protection requirement of Electromagnetic Compatibility (EMC) Directive 2014/30/EU on the approximation of the laws of the Member States relating to electromagnetic compatibility and Radio Equipment Directive (RED) 2014/53/EU to meet the regulation of the radio equipment and telecommunications terminal equipment.